

VEGGI MASTER

90-315 | 170-430



Die beste Wahl für kontinuierliches Schneiden von Gemüse und Obst in Würfel, Streifen und Scheiben

- Kompaktes Design für geringen Platzbedarf
- einfache Bedienung für müheloses Arbeiten und geringe Einarbeitungszeit
- Schneidqualität für höchste Ansprüche
- Kleine Würfelgrößen schon ab 3 mm / 4 mm
- Maschinengestell aus rostfreiem Edelstahl
- Hoher Sicherheitsstandard nach gültigen internationalen Normen
- Fahrbar mit Lenkrollen
- Wasseranschluss zum Durchspülen während des Schneidens
- Stufenlos regelbare Drehzahl

The best choice for continuous cutting of vegetables and fruits in cubes, strips and slices

- Compact machine design for small space requirements
- Simple operation for easy working and short time training
- The cutting quality fulfils highest requirements
- Small cutting sizes starting from 3mm / 4 mm
- Machine body made from stainless steel
- High safety standard according to valid international regulations
- Mobile on wheels
- Water connection for rinsing during cutting
- Speed infinitely variable

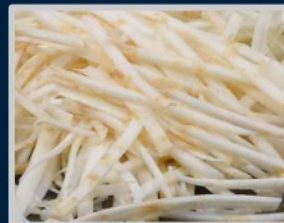
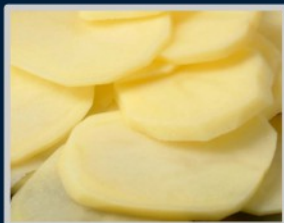
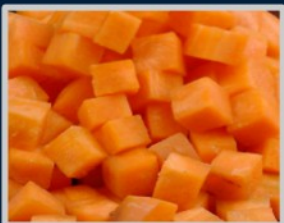

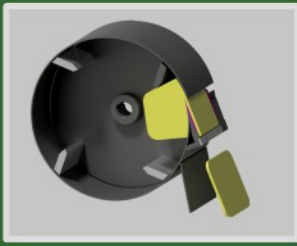

Schneiden von Scheiben mit dem Trennmesser
Cutting of slices with the block knife

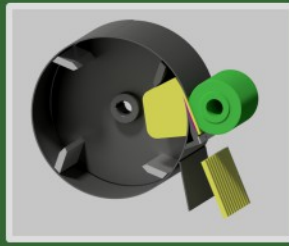

Schneiden von Streifen mit Trennmesser und oberen Kreismessern
Cutting of strips with block knife and upper circular knives

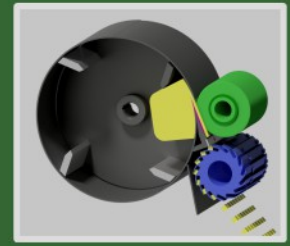

Schneiden von Würfeln mit Trennmesser, oberen Kreismessern und unteren Quermessern
Cutting of cubes with block knife, upper circular knives and lower cross knives

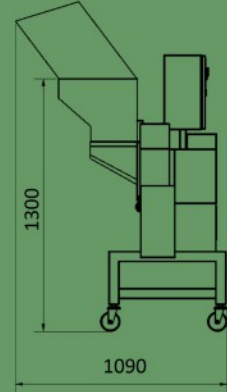
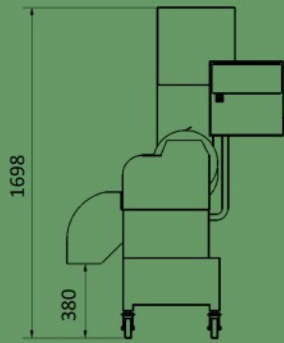

Durchsatz max. (abhängig von Würfelgröße und Produkt)	throughput max. (depend on cube size and product)	kg/h	850
Anschlusswert	connected load	kW	0,75
Durchmesser Einfülltrommel	diameter of infeed drum	mm	315
Breite Einfülltrommel	width of infeed drum	mm	90
Schneidgrößen	cutting sizes	mm	3 – 20
Drehzahl	speed	stufenlos regelbar / variable	
Gewicht	weight	kg	150

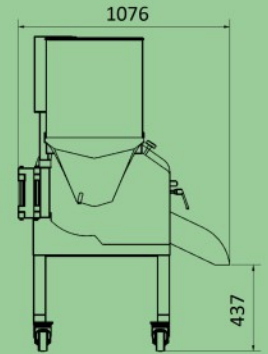
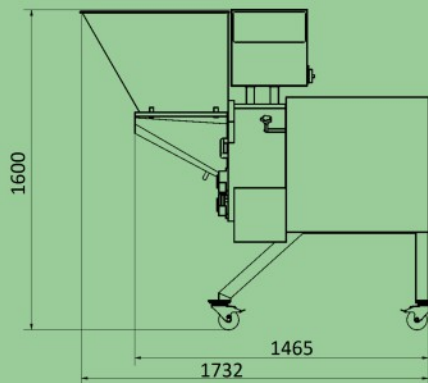

Durchsatz max. (abhängig von Würfelgröße und Produkt)	throughput max. (depend on cube size and product)	kg/h	2000
Anschlusswert	connected load	kW	1,5
Durchmesser Einfülltrommel	diameter of infeed drum	mm	430
Breite Einfülltrommel	width of infeed drum	mm	170
Schneidgrößen	cutting sizes	mm	4 – 20
Drehzahl	speed	stufenlos regelbar / variable	
Gewicht	weight	kg	300